

# Locke LB Buildings

*The Pole Building Experts!*

## **METAL SIDING AND ROOFING CATALOG**

Call or email for current pricing

503.630.3183

[sales@lockebuildings.com](mailto:sales@lockebuildings.com)

Visit our web site [lockebuildings.com](http://lockebuildings.com)

## TABLE OF CON- TENTS

### Roof & Wall Cladding

Exposed Fastener Panels . . . . .	3-4
Concealed Fastener Panels . . . . .	4-5
Mechanically Seamed Panels . . . . .	6
Steel Siding . . . . .	7
Metal Shingles . . . . .	8-10

### Trim

Standard Trim . . . . .	11
PBR Trim and Flashing . . . . .	12
Loc Seam/Chimney/Skylight Trim . . . . .	13
Soffit & Facia . . . . .	14
Metal Siding Trim . . . . .	15

### Doors

Walk Doors . . . . .	16
Roll Up Doors . . . . .	17-18
Arcadian Dutch Doors & Sliders . . . . .	19
Sliding Door Supplies . . . . .	20

### Fasteners

Wood Fasteners . . . . .	21
Self Drilling Fasteners . . . . .	22-23
Concrete Anchors . . . . .	24

### Insulation/Underlayment

25

### Sealants & Closure

Adhesive & Sealants . . . . .	26
Closure & Vent . . . . .	27

### Sheet Metal Tools

Hand Tools . . . . .	28-31
Saw Blades . . . . .	32-33
Drill Bits . . . . .	34
Safety . . . . .	35

### Accessories

Cupolas . . . . .	36
Horse Stall Components . . . . .	37
Pipe Flashing . . . . .	38
Light Panels . . . . .	38
Miscellaneous . . . . .	39

### 2' Delta Rib



- Full 24" net coverage
- Purlin-bearing edge for strength while fastening side lap
- Anti-siphoning side lap
- Custom lengths 3' through 40'0" in cut-to-length 1" increments

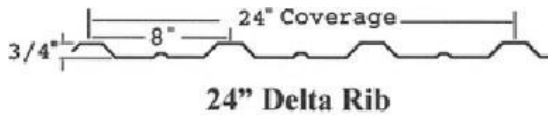

Style	Gauge	Price
Galvalume		
Painted		
Sale Material	Call for availability	

### 3' Magna Rib



- Full 36" net coverage
- Purlin-bearing edge for strength while fastening side laps
- Anti-siphoning side lap
- 8 intermediate stiffening ribs add extra strength to this panel
- Custom lengths 3' through 40'0" in cut-to-length 1" increments

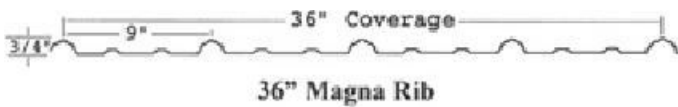

Style	Gauge	Price
Galvalume		
Painted		
Sale Material	29	

### 3' PBR

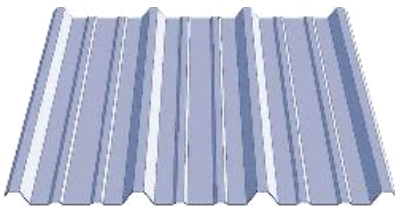

- Excellent for commercial and industrial applications
- 26 gauge full hard (80 ksi) steel
- PBR panels require a minimum slope of 1:12
- UL90 rating for PBR panels when attached to steel purlins
- Custom lengths 3' through 40'0" in cut-to-length 1" increments

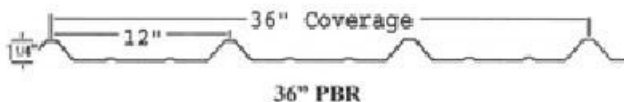

Style	Gauge	Price
Galvalume		
Painted		
Sale Material	26	

### 2 1/2" Corrugated



- 24" coverage for sidewall and 21 1/2" for roof
- Anti-siphoning side lap
- Custom lengths 3' through 40'0" in cut-to-length 1" increments

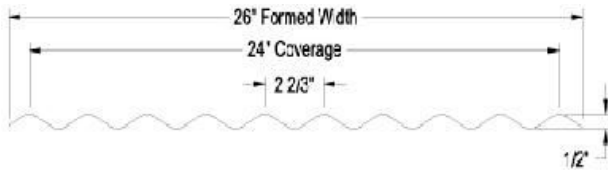

Style	Gauge	Price
Galvanized	29	
Painted	29	

### 12" or 16" Loc Seam



12" Loc Seam (shown w/beads)

- Low maintenance and easy installation
- Residential / Architectural application
- Direct fastened - no clips necessary
- Installed over solid substrates w/felt or synthetic underlayment
- On - site roll forming
- No exposed fasteners
- Minimum slope 3/12

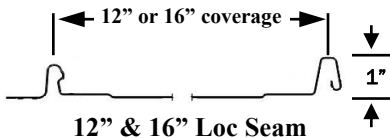

OPTIONAL: Beads or Striations

Style	Gauge	Price
12" Painted	26	
16" Painted	26	
12" SMP	24	
12" KYNAR	24	
12" Sale Material*	26	
16" Sale Material*	26	

\* call for available colors

### ClipLoc Standing Seam



18" ClipLoc (shown w/striations)

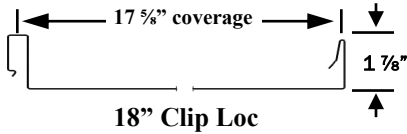

OPTIONAL: Beads or Striations

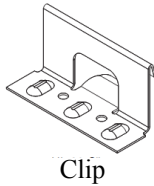

Clip

Our ClipLoc panel is a snap-together panel - no seaming required! They are engineered to exceed most wind load requirements in the country while enhancing the aesthetic appearance of a building, whether residential or commercial.

- 24 ga. Pre-painted Galvalume (22 gauge optional)
- .032/.040 Pre-painted Aluminum (plywood substrate)
- Can be installed over solid substrates, steel decking with polyiso, or in limited applications over open purlins
- Minimum slope:2/12 - optional factory or field applied side lap sealant
- Weathertight warranty optional
- Bold 1 7/8" tall seam
- Special clip allows for full 2" of thermal movement

Style	Coverage	Gauge	Price
ClipLoc	17 5/8"	24	
	13 3/4"	26	
Clips	UL Listed		
	Non-UL		



SSX Seamer

#### Specifications:

Designed for 1-1/2" Mechanical Seam  
 Front mounted auto / safety switch  
 Double Lock - single pass  
 Speed: 30 fpm  
 Power: 7 amps @ 120 volts  
 Weight: 35 lbs.  
 Capacity: 26 -24 Gauge Steel  
 .024 - .032" Aluminum

### Mechanical Seamers

	Daily Rental	Weekly Rental
SSX Seamer		
SS Industrial Seamer		



SS Industrial Seamer

#### Specifications:

Designed for 2" Mechanical Seam  
 Front and rear safety auto-shutoffs included  
 Bi-directional 90° single lock seaming in one pass  
 Single direction 180° double lock seaming in one pass  
 Weight: 89 lbs., 24" Length  
 Power: 11.5 amps @ 110 volts  
 Capacity: 22 - 24 gauge Steel

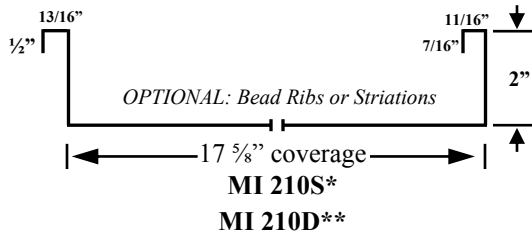
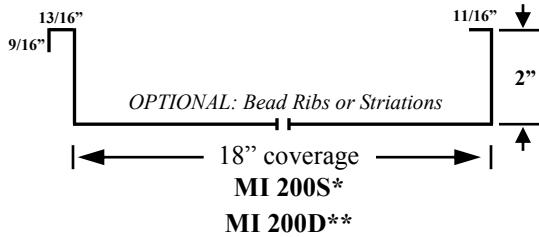
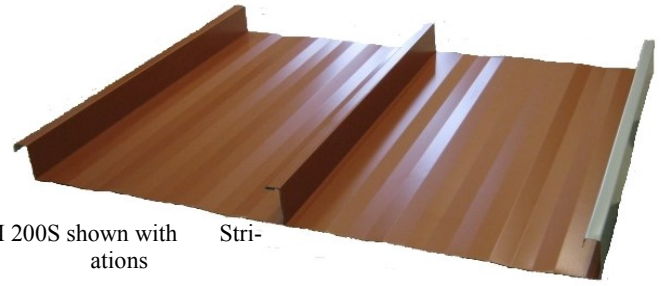
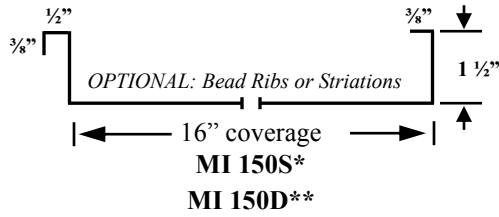

Our mechanically seamed panels enhance the aesthetic appearance of a building, whether residential or commercial. They are engineered to exceed most wind load requirements in the country and can be used to fit the needs of new construction or retrofit applications.

- 24 ga. Pre-painted Galvalume (22 gauge optional)
- .032/.040 Pre-painted Aluminum (plywood substrate)
- Can be installed over open purlins, steel decking with polyiso, or solid substrates
- Minimum slope: 1/2/12 - optional factory or field applied side lap sealant
- Weathertight warranty optional
- Single and Double Lock Seamers available
- Clip system allows for thermal expansion/contraction.

Style	Coverage	Gauge	Price
<b>MI 150</b>	16"	24	
<b>MI 200</b>	18"	24	
<b>MI 210</b>	17.5"	24	
<b>1.5" Clip</b>	Floating		
<b>2" Clip</b>	Floating		

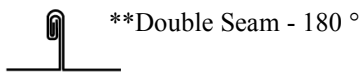
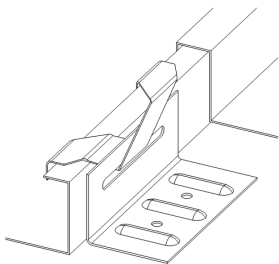

**Tested (varies by panel) in accordance with:**

ASTM E1592 Uniform Static Air Pressure Uplift	UL Environmental - SRI Third Party Verified
ASTM E1646 Water Infiltration	UL 1897 Extended Phase Wind Uplift
ASTM E1680 Air Infiltration	UL 2218 Class 4 Hail Impact
ASTM E1886 Missile Impact	UL 263 Fire Certification
TAS 100 Wind Driven Rain	UL 790 Class A Fire Rating
TAS 125 Wind Uplift Test	UL 580 Wind Uplift (Class 90)
FM4471 Concentrated Load Foot Traffic	ASTM 2140 Static Pressure Water Head





### Seamless Siding

- Much more durable than wood or vinyl
- Will not crack in cold temperatures
- Low maintenance
- Seamless (No end-lap joints)

Profile	Gauge	Price
Standard Lap	26	
Dutch Lap	26	
Board & Bat	26	



#### Standard Lap

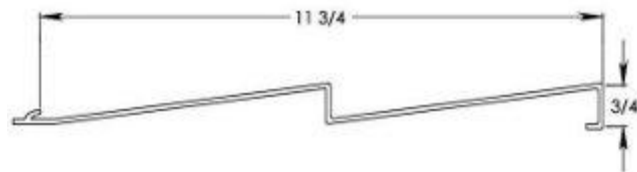

#### Dutch Lap

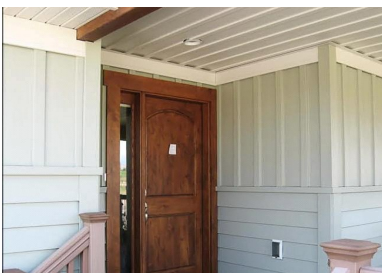
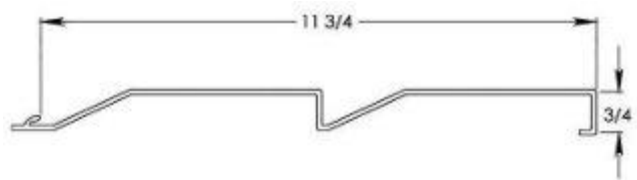

#### Board & Batt

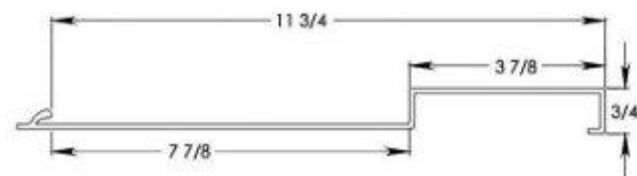

### Decra Roofing

~ see enclosed brochure ~

- Stone coated steel shingle
- Non-combustable class A rated material
- Walkable — low maintenance
- Interlocking panels provide weather tight barrier
- Transferable 50-year limited warranty
- Call for pricing on accessories



Profile	Price
Shingle	
Shingle Plus	
Shake	
Tile	

### Met-tile “tile panel” Roofing

~ see enclosed brochure ~

- The beauty of tile without the weight
- Made of 26 gauge commercial grade steel
- Excellent energy saving and disaster performance
- Specifically designed to seal out wind and weather
- Comes with a 20 yr. Warranty
- Call for pricing on accessories

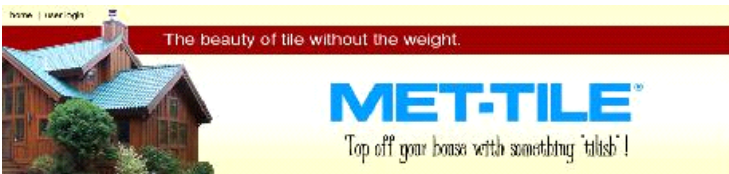

Price



- Stone coated steel
- Non-combustable class A rated material
- Walkable — low maintenance
- Lightweight
- Transferable 50-year limited warranty

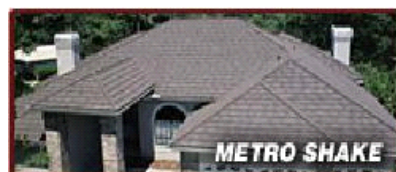

Profile	Price
Shingle	
Shake	
Tile	
Roman Tile	





- 12" x 50" Interlocking Shingle—Shake
- Galvanized Steel Substrate
- Fluoropolymer PVDF Finish (Kynar 500)
- Double Embossed Cedargrained texture for extra strength
- 22 Designer colors
- Concealed fastening system
- Unique embossed roll formed accessory package
- Limited Lifetime Warranty program
- Wind and Fire Ratings

Profile	1-5 square	6+ square
Shingle Shake 30 ga.		
Slate 28 ga.		
Shingle Shake <i>enhanced</i>		
Slate <i>enhanced</i>		

- Freight prepaid on all order quantities
- Accessories ordered alone are shipped freight collect
- Bright Red has a 20% upcharge
- PRICES SUBJECT TO CHANGE WITHOUT NOTICE



Shingle-Shake Panel  
50" x 12" – 12 pcs / ctn  
50 sq ft coverage



Shingle-Shake Ridge/Hip Cap  
20 pcs / ctn

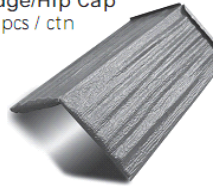

### Shake & Slate Accessories

*\*All accessories are velvet embossed*

Slate Panel  
50" x 12" – 12 pcs / ctn  
50 sq ft coverage

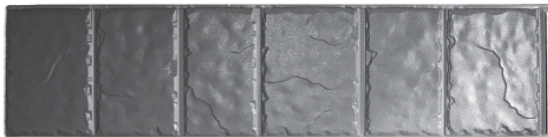

Slate Ridge/Hip Cap  
20 pcs / ctn

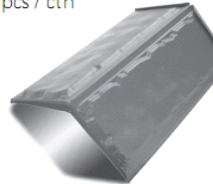

Eave Starter  
10' long



7/8" J-Trim  
10' long



Open Valley Flashing  
10' long



Valley Flashing  
10' long



Valley Cap  
10' long



End Wall Flashing  
10' long

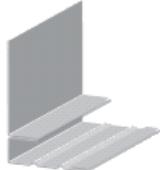

Rake Starter  
10' long



Shingle Clip  
Valley Clip  
750 / ctn  
.020" G90

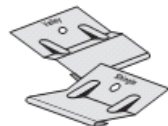

Trimline Vent  
10' long  
w/foam

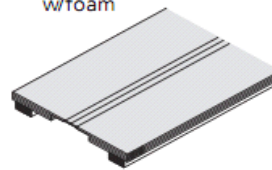

Starter Base  
10' long



AVAILABLE COLORS	
Shingle Shake	Royal Brown, Hartford Green, Classic Blue, T-Tone, Sandtone, Statuary Bronze, Glacier White, Pewter, Desert Tone, Classic Red, Charcoal Gray, Spruce Green, Cedar, Bright Red, Copper
Slate	Hartford Green, Classic Red, Charcoal Gray, Stone
Shingle Shake Enhanced	T-Tone Blend, Charcoal Blend, Hartford Green Blend, Royal Brown Blend
Slate Enhanced	Charcoal Gray Blend, Stone Blend, Classic Red Blend

PRODUCT	PRICE	PCS/CTN	QUANTITY
Shingle-Shake/Slate	(see previous pg)	12	50 sqf / ctn
Eave Starter	Call For Price	10	
Rake Starter	Call For Price	10	
7/8" J Trim	Call For Price	10	
End Wall Flashing	Call For Price	5	
Valley Flashing	Call For Price	5	
Valley Cap	Call For Price	5	
Trimline Vent	Call For Price	5	
Starter Base	Call For Price	5	
S. Base w/Foam	Call For Price	5	
12" Ridge/Hip Cap	Call For Price	20	
Shingle Shake Clip	Call For Price	750	
Valley Clip	Call For Price	750	

Install manual available at: <http://edcoproducts.com/pdf/Arrowline-Install-Manual-05-2006.pdf>

All trim is in 10'-3" lengths - up to 21'-3" lengths available. \*Specify pitch.

### Ridge Cap\*

29 gauge  
26 gauge

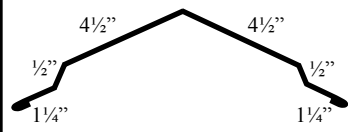

### Gable Trim

29 gauge  
26 gauge

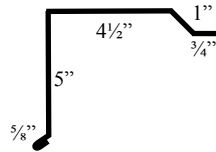

### Eave Trim\*

29 gauge  
26 gauge

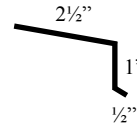

### W Valley\*

29 gauge  
26 gauge

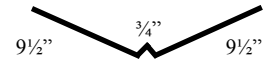

### Endwall Trim\*

29 gauge  
26 gauge

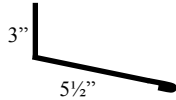

### Top Shed\*

29 gauge  
26 gauge

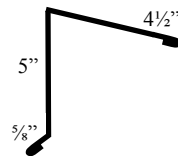

### Pitch Change\*

29 gauge  
26 gauge

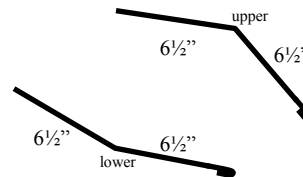

### Sidewall

29 gauge  
26 gauge



### Outside Corner

29 gauge  
26 gauge

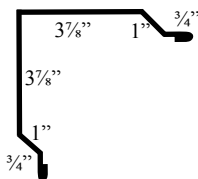

### Inside Corner

29 gauge  
26 gauge

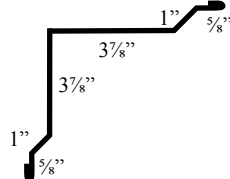

### C Casing

29 gauge  
26 gauge

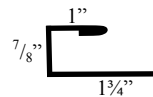

### Wall to Light

29 gauge  
26 gauge

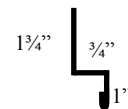

### Upper Flash\*

29 gauge  
26 gauge

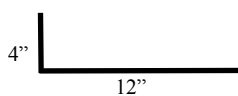

### Snow Break

29 gauge  
26 gauge

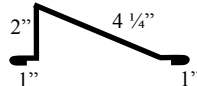

### Jamb Cap

29 gauge  
26 gauge

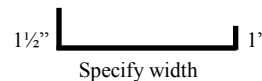

### Rodent Guard

29 gauge  
26 gauge

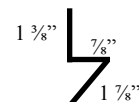

### Track Cover

29 gauge  
26 gauge

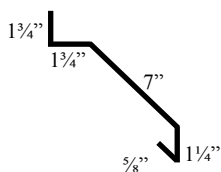

### Double Track Cover

29 gauge  
26 gauge

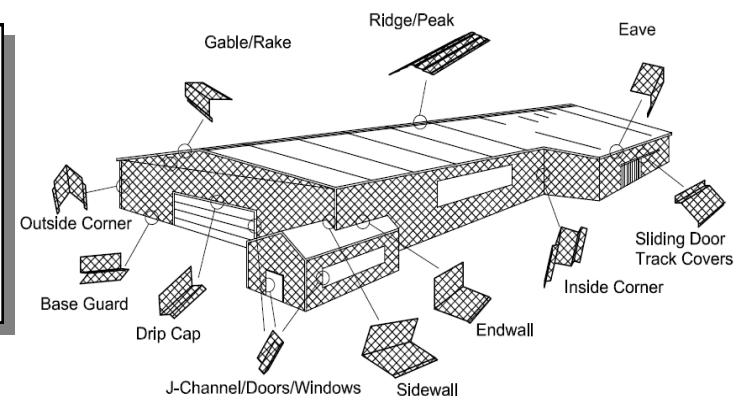
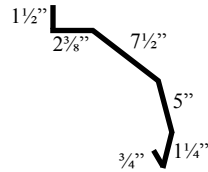

All trim is in 10'-3" lengths - up to 21'-3" lengths available. \*Specify pitch.

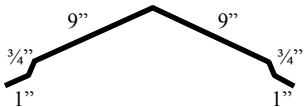
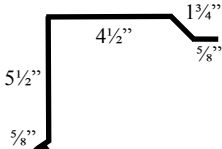
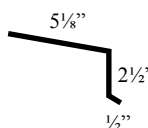
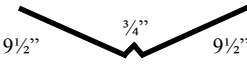
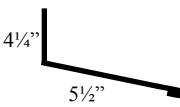
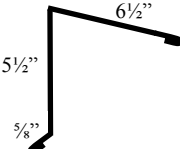
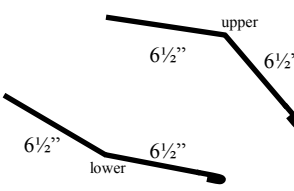
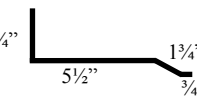
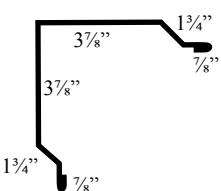
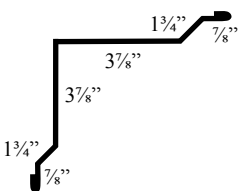
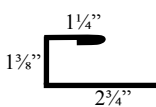
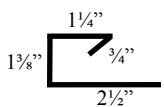
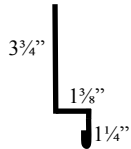
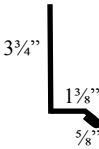
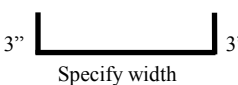
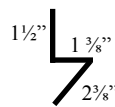
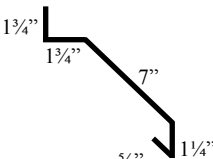
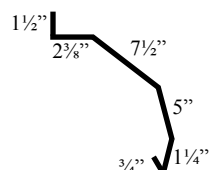
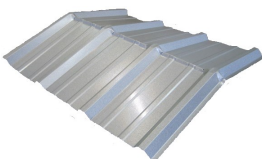
<p><b>Ridge Cap*</b> 29 gauge 26 gauge</p> 	<p><b>Gable Trim</b> 29 gauge 26 gauge</p> 	<p><b>Eave Trim*</b> 29 gauge 26 gauge</p> 	<p><b>W Valley*</b> 29 gauge 26 gauge</p> 
<p><b>Endwall Trim*</b> 29 gauge 26 gauge</p> 	<p><b>Top Shed*</b> 29 gauge 26 gauge</p> 	<p><b>Pitch Change*</b> 29 gauge 26 gauge</p> 	<p><b>Sidewall</b> 29 gauge 26 gauge</p> 
<p><b>Outside Corner</b> 29 gauge 26 gauge</p> 	<p><b>Inside Corner</b> 29 gauge 26 gauge</p> 	<p><b>Open C Casing</b> 29 gauge 26 gauge</p> 	<p><b>Closed C Casing</b> 29 gauge 26 gauge</p> 
<p><b>Wall to Light Flash</b> 29 gauge 26 gauge</p> 	<p><b>Base Trim</b> 29 gauge 26 gauge</p> 	<p><b>Jamb Cap</b> 29 gauge 26 gauge</p> 	<p><b>Rodent Guard</b> 29 gauge 26 gauge</p> 
<p><b>Track Cover</b> 29 gauge 26 gauge</p> 	<p><b>Double Track Cover</b> 29 gauge 26 gauge</p> 	<p><b>PBR Formed Ridge</b> 26 gauge only</p>  <p>36" x 36" coverage</p>	<p><b>Custom Trim</b></p>



## Loc Seam Trim & Flashing

All trim is in 10'-3" lengths - up to 21'-3" lengths available. **\*Specify pitch.**

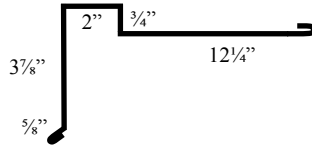
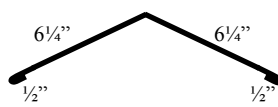
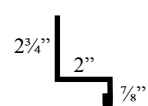
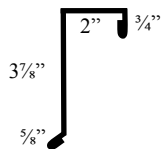
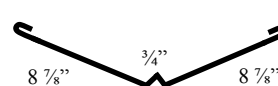
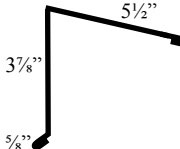
<p><b><u>Prow Gable Trim</u></b> 29 gauge 26 gauge</p> 	<p><b><u>Hip Cap*</u></b> 29 gauge 26 gauge</p> 	<p><b><u>Loc Seam Sidewall</u></b> 29 gauge 26 gauge</p> 
<p><b><u>Loc Seam Gable</u></b> 29 gauge 26 gauge</p> 	<p><b><u>Loc Seam W Valley*</u></b> 29 gauge 26 gauge</p> 	<p><b><u>Loc Seam Top Shed*</u></b> 29 gauge 26 gauge</p> 

## Chimney & Skylight Flashing

All trim is in 10'-3" lengths - up to 21'-3" lengths available. **\*Specify pitch.**

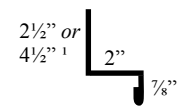
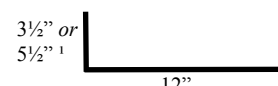
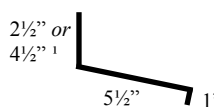
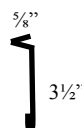
<p><b><u>Sidewall</u></b> 29 gauge 26 gauge</p>  <p><sup>1</sup>Specify curb height</p>	<p><b><u>Upper Flash*</u></b> 29 gauge 26 gauge</p>  <p><sup>1</sup>Specify curb height</p>	<p><b><u>Lower Flash*</u></b> 29 gauge 26 gauge</p>  <p><sup>1</sup>Specify curb height</p>	<p><b><u>Chimney Counterflash</u></b> 29 gauge 26 gauge</p> 
--	--	---	---

### Trim Locations





All trim is in 10'-3" lengths - up to 21'-3" lengths available. \*Specify pitch.

### Facia & Soffit Parallel Eave

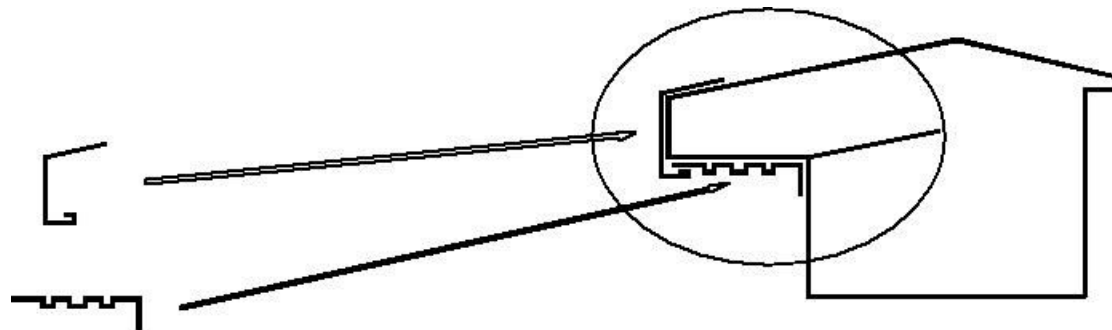

Profile	29 ga. Price	26 ga. Price
Facia Gable*	Call for price	
Soffit Gable	Call for price	

### Pitch Facia & Eave

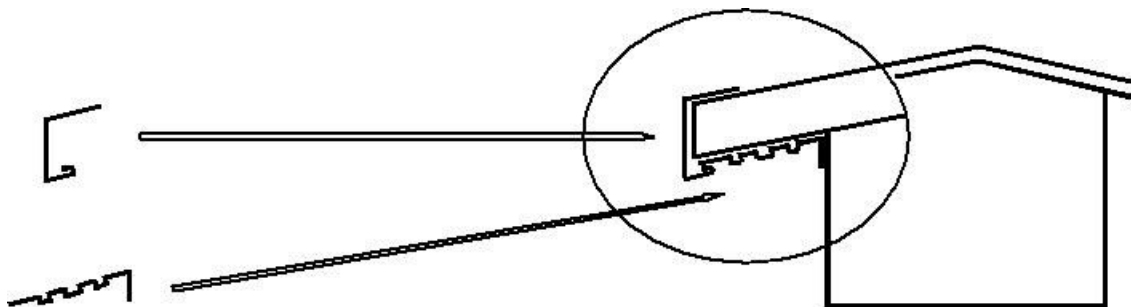

Profile	29 ga. Price	26 ga. Price
Facia Gable*	Call for price	
Soffit Gable*	Call for price	

### Gable Facia & Soffit

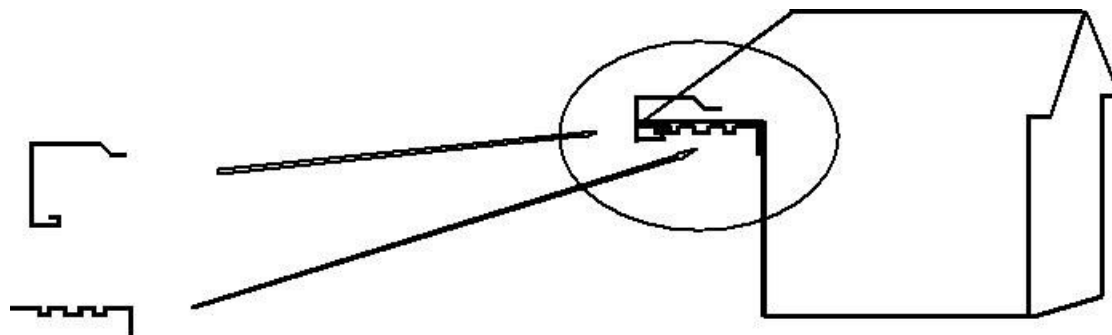

Profile	29 ga. Price	26 ga. Price
Facia Gable	Call for price	
Soffit Gable	Call for price	

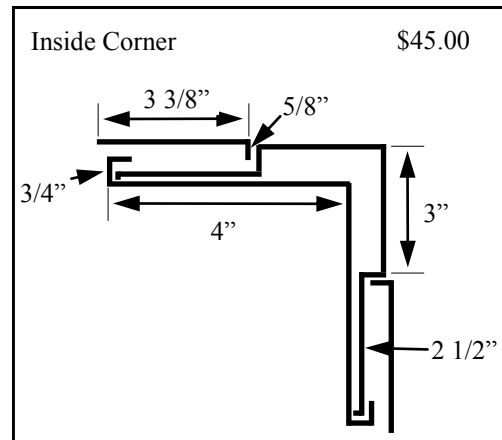
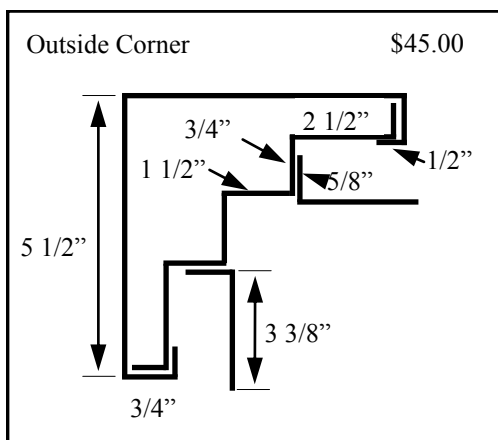
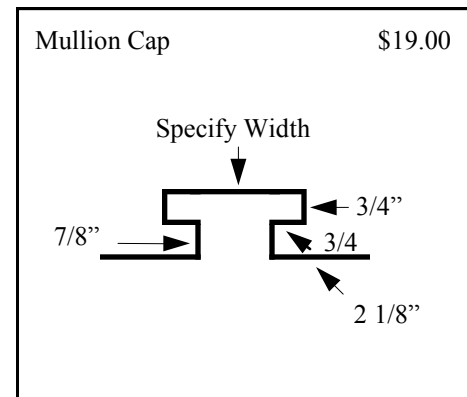
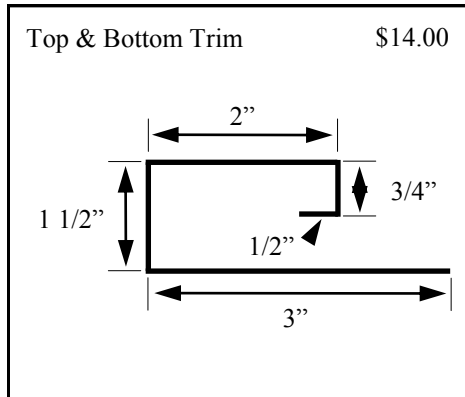
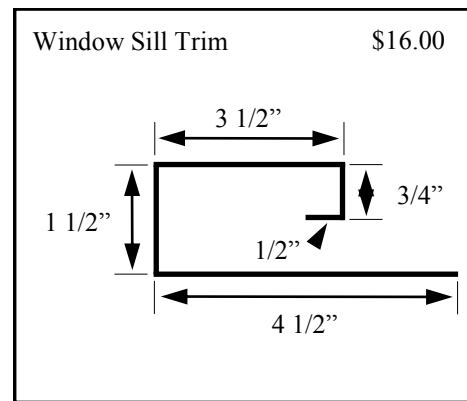
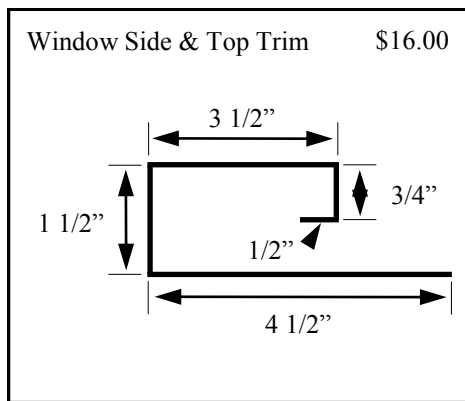
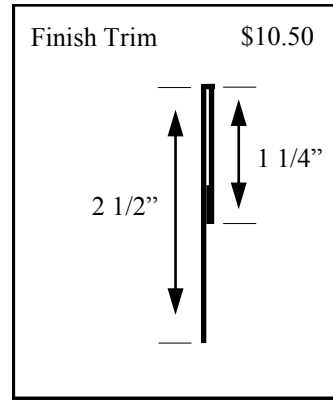
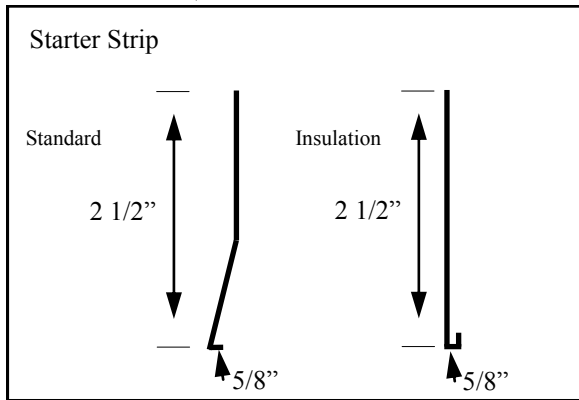



### Series 99

- Durable white painted embossed steel skins standard
- High tensile aluminum panel surround with reinforced corners for maximum strength
- 3 1/2" Pre-hung 4-way universal swing jamb system
- Optional fixed pin hinges for extra security
- Polyurethane foam core, R-value 9.5
- 3'-0" x 6'-8" Rough opening: 38 1/8" x 82 1/4"
- 4'-0" x 6'-8" Rough opening: 50 1/2" x 82 1/4"
- 6'-0" x 6'-8" Rough opening: 75 1/2" x 82 1/4"
- Full perimeter weather stripping, 3 stainless steel fixed pin hinges, and keyed lockset included

Size	Price
3'-0" - 6'-8"	
4'-0" - 6'-8"	
6'-0" - 6'-8"	



### Series 95 & 94

#### Series 95

- Painted steel 16 gauge steel jamb
- 28 gauge smooth steel panel, polar white crystal coat finish
- 3'-0" x 6'-8" Rough opening: 38 1/2" x 82 1/4"

#### Series 94

- 24 gauge smooth steel panel, baked-on white enamel finish
- Pre-painted aluminum frame (white)
- Embossed six panel or cross buck design is available in bone white
- Window options available
- 3'-0" x 6'-8" Rough opening: 40 1/2" x 82 1/4"
- 4'-0" x 6'-8" Rough opening: 51" x 82 1/4"
- 6'-0" x 6'-8" Rough opening: 77 3/4" x 82 1/4"

#### Both series 95 & 94

- 3 1/2" Pre-hung 4-way universal swing jamb system
- Polyurethane foam core, insulating value R-12
- Full perimeter weather stripping, 3 stainless steel fixed pin hinges, and keyed lockset included

#### Series 95

Size	Price
3'-0" x 6'-8"	

#### Series 94

Size	Price
3'-0" x 6'-8"	
4'-0" x 6'-8"	
6'-0" x 6'-8"	





America's Favorite Garage Doors®



- Embossed 25 gauge steel panels
- 15 year paint system
- Five factory finish paint colors
- Tongue-and-groove section joints
- 2" thick frame construction
- Woodgrain textured short and long raised panel designs
- Model T52: Polystyrene vinyl-backed insulation, R-value 6.3
- Many window options available
- Call us for custom size availability

### Model T50 Non-insulated

Height> Width	7'	8'	9'	10'	12'	14'	16'
8'							
9'							
10'							
12'							
14'							
15'							
16'							

### Model T52 Insulated

Height> Width	7'	8'	9'	10'	12'	14'	16'
8'							
9'							
10'							
12'							
14'							
15'							
16'							

### Door Installation Prices

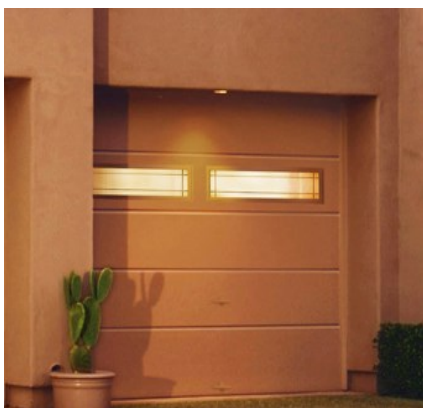

	Price	Price
<b>Item</b>	Call for pricing	Call for pricing
Overhead Door Delivery (\$105.00 max)		
Overhead Door Install (\$150.00 min.)		
Operator Install		
High-lift Track Install (priced per foot of high lift)		
Low Headroom Track Install		
Pre-existing Door Removal & Disposal		
Dirt Floor Surcharge		
Trip Charge (outside of 50 mile radius) \$50.00 minimum		



### Dutch/Bale Doors

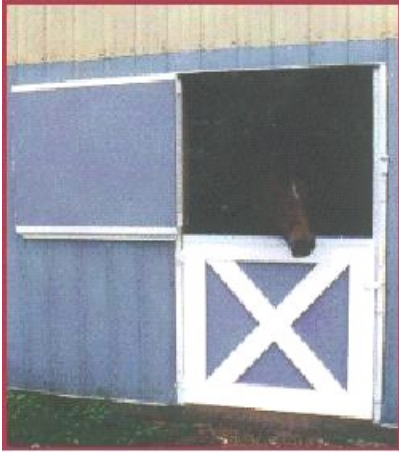

- Fabricated from 16 ga. Galvaneal
- Feature one piece cut laser design
- Standard D-Latch
- 3-piece frame prepped with hinges
- \*Price does not include freight - call for freight quote
- Assembled Premium Dutch & bale doors include: One piece laser cut door panels, Cross bucks, 29 ga. Steel insert, Plywood core, Hinges, Barrel bolt, D-Latch, Fasteners & Door Catch



		Price*	Price*
Item	Rough Opening	Standard	W/Window
Dutch Door	49 1/8" x 87 1/2"		
Bale Door	49 1/8" x 43 3/4"		





### Sliding Door Kits





All Kits include:



Track, Splice Collar, Trolley Set, Track Cover Brackets, Side Rails, Adjustable Offset Stay Roller, Door Pull, 7 1/2" Cam Latch, 2 Adjustable Door Stops









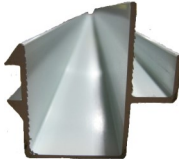

Size	Price
4' x 8'	
10' x 10'	
12' x 12'	
14' x 14'	

<p><b>Round Track Topmount</b></p>  <p>Available in 8' - 14' Lengths in 2' multiples</p>	<p><b>Round Track Facemount</b></p>  <p>Available in 8' - 14' Lengths in 2' multiples</p>	<p><b>Round Track Studmount</b></p>  <p>Available in 8' - 14' Lengths in 2' multiples</p>	<p><b>Trolley Set 9" Offset Bolt</b></p>  <p>600lb. Rating</p>	<p><b>Splice Collar</b></p> 
---	--	--	--	---

<p><b>Double Track Support w/ Welded Bracket</b></p> 	<p><b>Double Track Side-mount Bracket</b></p> 	<p><b>Single Track Adjustable Bracket</b></p> 	<p><b>Standard Track Cover bracket</b></p> 
--	---	--	--

<p><b>Adjustable Offset Stay Roller</b></p> 	<p><b>Small Adjustable Stay Roller</b></p> 	<p><b>12" Cane Bolt</b></p> 	<p><b>White Aluminum Side Rail</b></p>  <p>Available in 8', 10', 12', 14', 16'</p>
---	--	---	---

<p><b>Non-adjustable Door Stop</b></p> 	<p><b>Adjustable Door Stop</b></p> 	<p><b>Bi-pass Door Guide</b></p> 	<p><b>White Aluminum Side Rail w/adaptor</b></p>  <p>Available in 8', 10', 12', 14'</p>
--	--	---	--

<p><b>6" Gate Hook</b></p> 	<p><b>Sliding Bolt Latch</b></p> 	<p><b>Cam Latch</b></p>  <p>Adjustable cam action</p>	<p><b>White Door Pull</b></p> 
---	--	---	---

### 3/4 Stitcher (sheet metal to sheet metal)



- Used for ridge fastening
- High Hex Washer Head provides driving stability
- Assembled with a control seal washer for a consistent, weather tight seal
- Zinc plated and Silver Senti™ coated for corrosion protection.

Length	Quantity	Head Size	Price
3/4" Painted	250	1/4" Hex	
3/4" Galvanized	250	1/4" Hex	

### Roof & Wall Screw

- High Hex Washer Head provides driving stability
- Assembled with a control seal washer for a consistent, weather tight seal
- Alternate mechanical zinc (.001" min thick) plus Silver Senti™ coated offers increased corrosion protection



Length	Quantity	Head Size	Price
1" Painted	250	1/4" Hex	
1" Galvanized	250	1/4" Hex	
1 1/2" Painted	250	1/4" Hex	
1 1/2" Galvanized	250	1/4" Hex	
2" Painted	250	1/4" Hex	
2" Galvanized	250	1/4" Hex	
3" Galvanized	250	1/4" Hex	

### Pancake Head Screw

- Designed for areas where a low profile is essential
- Recommended for our Loc Seam panel



Length	Quantity	Head Size	Price
1" Painted	250	#2 Philips	
1 1/2" Galvanized	250	#2 Philips	

### Rivets

- Provides a low visibility trim connection
- Suited for downspouts, gutters and corner trim



Size	Quantity	Price
1/8"x5/16" Painted	To Order	

### 14-14 x 7/8" T1 (sheet to sheet)



- Stitching screw used for sheet to sheet
- Ideal for bonding lap seams in light gauge panels
- 1,000 hr. salt spray coating

Length	Diameter	Quantity	Head Size	Price
7/8" Painted	#14	250	5/16" Hex	
7/8" Galvanized	#14	250	5/16" Hex	

### 12-14 T-3 With Seal (sheet to steel)



- Used for pan fixing steel panels on the wall and roof
- Has a 9/16" O.D. washer and rubber seal
- 1,000 hr. salt spray coating

Length	Diameter	Quantity	Head Size	Price
1" Painted	#12	250	5/16" Hex	
1" Galvanized	#12	250	5/16" Hex	
1 1/2" Painted	#12	250	5/16" Hex	
1 1/2" Galvanized	#12	250	5/16" Hex	

### 12-14 T-3 With Seal (available for wood also)



- Used for crest fixing panels on the roof
- Has a 9/16" O.D. washer and rubber seal
- Secondary thread under shank pulls metal upward preventing any water penetration
- 1,000 hr. salt spray coating

Length	Diameter	Quantity	Head Size	Price
1 7/8" Painted	#12	250	5/16" Hex	
1 7/8" Galvanized	#12	250	5/16" Hex	
2 3/8" Painted	#12	250	5/16" Hex	
2 3/8" Galvanized	#12	250	5/16" Hex	
3 1/4" Painted	#12	To Order	5/16" Hex	
3 1/4" Galvanized	#12	To Order	5/16" Hex	

### 12-14 T3 With Polyseal shank (fiberglass to steel)

- Special washer designed for crest fixing fiberglass skylight panels
- 1,000 hr. salt spray coating



Length	Diameter	Quantity	Head Size	Price
1 3/4" Painted	#12	250	5/16" Hex	
2 1/4" Galvanized	#12	250	5/16" Hex	

### 12-14 x 3/4 (steel to steel)

- Medium duty structural framing (doors, windows)
- 1,000 hr. salt spray coating



Length	Quantity	Head Size	Price
3/4"	250	5/16" Hex	

### 14-14 x 1" T-3 (steel to steel)

- Heavy duty structural framing
- 1,000 hr. salt spray coating



Length	Quantity	Head Size	Price
1"	500	3/8" Hex	

### 12 or 14-24 x 1-1/2" T-5 (steel to steel)

- Used for drilling through thick or multiple layers of steel
- Ideal for double knee and apex bracing
- 1,000 hr. salt spray



Diameter	Length	Quantity	Head Size	Price
#12	1 1/4"	To Order	5/16" Hex	
#14	1 1/2"	50	3/8" Hex	

### 10-16 T-3 (wood to steel)

- Designed for attaching wood to structural steel
- Special ribbed head seats itself flush into the wood for easy top finishing
- Ideal for putting sub flooring on steel mezzanines



Length	Quantity	Head Size	Price
1 7/16"	To Order	#2 Philips	
2 1/4"	To Order	#2 Philips	
3"	To Order	#2 Philips	

### 10-16 x 1" T-2 (sheet to steel)

- Designed for areas where a low profile is essential
- Recommended for attaching C casing to allow panels to slide into the trim without hanging up on a traditional hex head

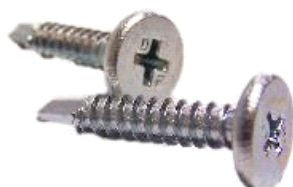

Length	Quantity	Head Size	Price
1"	To Order	# 2 Philips	





## Concrete Anchors

### Concrete Spike

- Patented, one-piece, tamper resistant anchor
- Formed with an “S” shaped configuration to create an expansion mechanism
- Use for base angles and door jamb base brackets

Size	Price
1/4” x 1”	

### Wedge-Bolt



- A one piece heavy duty anchor for use in concrete, block or brick
- Features a finished hex head, integral washer, a patented dual thread and chamfered tip
- Requires matched tolerance WEDGE-BIT (see page 23)
- Dip wedge bolt into lubricating oil prior to installation

Size	Price
1/2” x 2 1/2”	
1/2” x 3”	
1/2” x 5”	
5/8” x 5”	



### Frame Bolt Assembly

- A307 bolt with nut and two washers

Length	Quantity	Head Size	Price
1/2” x 1 1/4”	200	15/16” Hex	



### Frame Bolt Assembly

- The 5/8” assembly has a flanged head nut and bolt (no washers)

Length	Quantity	Head Size	Price
5/8” x 1 1/4”	40	15/16” Hex	

### Dura-Skrim®

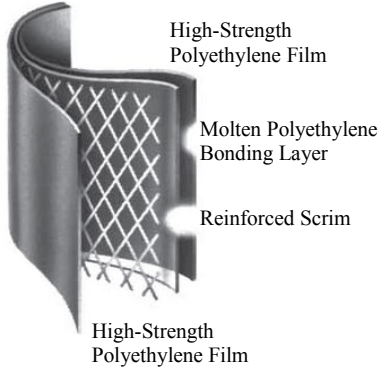

- Excellent choice as an in-wall and roof vapor retarder
- Heavy-duty scrim reinforcement, laminated between two layers of virgin high-strength polyethylene film
- Resists punctures and immediately stops tears
- Accordion folded and tightly rolled on a heavy-duty core for ease of handling and time-saving installation
- UV stabilizers increase longevity
- 6 mil thickness



Size	R-Value	Price
6' x 100'	none	
12' x 100'	none	

### Low - E Vapor Plus and Low-E Foil

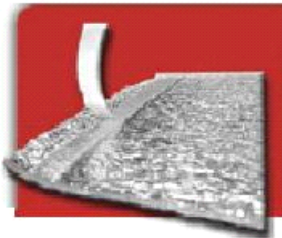

- Saves time and money
- Non - toxic — No fiberglass
- Seals tight around fasteners
- Certified ASTM testing
- Microcell polyethylene foam construction
- Improve energy efficiency
- Vapor barrier and thermal break all in one

Size	R-Value	Price
4' x 100'	7-10	
4' x 100'	3-4	

### Felt Paper

- Manufactured from premium quality organic mat and saturated with high-grade asphalt
- Dimensions: 3' x 72'
- Approx. weight per roll: 35 lbs.

Type	Price
30# Non-ASTM	2 square roll - \$19/roll

### Safeguard 30 Synthetic Underlayment

- Hybrid technology combines asphaltic polymer & synthetic fabrics
- Slip-resistant
- Meets or exceeds ASTM D226
- 30 year limited warranty
- Thermal stability in excess of 260 F
- Dimensions: 3' x 145', 50# per roll

Type	Price
Safeguard 30	

### Ice & Watershield

- Modified rubberized asphalt Peel & Stick underlayment
- 30 year limited warranty
- 240°F temperature rating
- Slip-resistant technology
- Self-seals around nails
- Dimensions: 3' x 72', 48# per roll

Type	Price
Ice & Watershield	

### Condensation Control Blanket

- Helps reduce exterior / interior noise
- Eliminates drafts
- Available in cut-to-length
- Allow 1 week notice



Width	Thickness	R-Value	Price
4' or 6'	1 1/2"	3-4	
4' or 6'	3"	10	
4' or 6'	4"	13	
4' or 6'	6"	19	

### Embossed Vinyl Tape



- Thin, strong, conformable, premium vinyl tape
- Particularly aggressive acrylic adhesive system
- Shrink and plasticizer resistant.

Size	Price
3" x 50'	
3" x 50' reinforced	

### 5 mil (12 micron) Double Coated Polyester Film



- High tack, high adhesion, high shear strength
- Excellent low and elevated temperature performance
- Bonds well to papers with high moisture content.

Size	Price
1 1/2" x 180'	
1 1/2" x 180' glue strip	

### Butyl Clay



- Excellent for sealing edges and seams on metal roof
- Excellent flexibility over wide temperature range
- Long term durability

Size	Price
3/32" x 3/8" x 45'	

### CLEAR Seal



- Universal sealant good for all seasons and reasons
- Sticks to almost anything
- Apply in all weather
- Available in a variety of colors

Size	Price
10 oz.	

### Closure

- Made of ESMP foam
- Resists UV rays
- Blocks moisture/water and bugs



	Inside	Outside
Profile	Price	Price
2' Delta Rib		
3' Magna Rib		
3' PBR		
16" Loc Seam/36" Length		
12" Loc Seam/48" Length		
16" Ultra Loc/36" Length		

### Uni-Seal



- Will conform to almost any roof panel
- Compresses and fills every void
- Factory applied glue strip

Size	Price
1" x 1" x 20'	

### Uni-Vent II



- A foam closure that allows venting at the ridge
- Will conform to any roof pane
- Compresses and fills every void
- Factory applied glue strip



Available in pre-cut lengths for Loc Seam

Size	Price
1" x 2" x 20'	
1 1/2 x 2 x 25'	
Pre-cut 1" x 2" x 12"	
Pre-cut 1" x 2" x 16"	

### Screen Vent

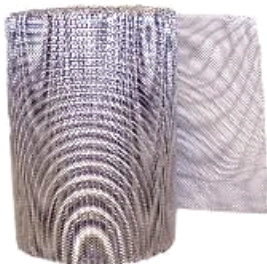

- A wire mesh screen excellent for venting a ridge
- Small enough mesh to keep birds and bugs out

Size	Price
6"	
8"	

### 3-Station Edge Roller



- For clean, crisp bends in metal roofing materials!
- Quickly adjusts for making 5/8" to 4" (16 to 102 mm) bends in 29 to 22-gauge (0.36 to 0.76 mm) steel.
- Exclusive 3-station roller design produces a uniform bend out to the very ends of a straight panel length.
- Center roller station is also independently adjustable for making mild-angled bends on a curve.
- Hardened rollers assure long, service life.

Also adjusts for making **curved bends!**



Capacities in Steel	Bending Depth	Weight	Price
29ga. - 22ga.	5/8" - 4"	8.5 lbs. (3.9 kg.)	

ERGONOMIC GRIP  
maximizes power

### MAX 2000 Aviation Snips



Extra long life  
compression  
spring.

- Hardened alloy steel blades offer maximum edge life
- Steel handle shaft extends through full length of grip
- Extra long life compression spring
- Ergonomic Grip Features
  - Multi-operational latch is accessible from right, left or top
  - Color-coded TPE (thermoplastic elastomer) upper grip
  - Nylon lower grip
  - Extra long life compression spring



**Nothing outcuts,  
outmaneuvers  
or outlasts MAX!**

Application	Length of Cut	Grip Color	Ergonomic Price
Cuts Left	1.375"	Red	
Cuts Right	1.375"	Green	
Cuts Straight, Left & Right	1.687"	Yellow	





Out set included

### Turboshear HD



- Inserts into chuck of 14.4 volt or larger A/C or cordless drill
- Clamping device is standard with the TurboShear
- Navigates tight patterns and square cuts
- Cuts a variety of building materials with the ability to reposition upside down for greater maneuverability
- 18 gauge capacity in galvanized steel
- Long-life, dual ball bearings
- The TurboShear HD also makes angled crosscuts through profiles of metal building panels and stone coated metal shingles.

Wider-opening jaws for navigating over profiles and through seams.

Non-slip shaft for higher torque cutting.



Long-life, dual ball bearings.



ONE-HAND OPERATION

Item	Price
TurboShear	
Replacement Blade	

ERGONOMIC GRIP maximizes power stroke of hand



### MAX 2000 Offset Aviation Snips

- The serrated upper jaw offers solid gripping power with less burr
- Ground tips on jaws allow access in tight areas
- Has the ability to make nickel size blind hole cuts
- Offset cutting plane makes trim cuts both accessible and efficient
- Steel handle shaft extends through full length of grip
- Extra long life compression spring



Style	Application	Length of Cut	Grip Color	Price
Left	Cuts sharp left angles, straight and 5" circles	1.25"	Red	
Right	Cuts sharp right angles, straight and 5" circles	1.25"	Green	

### Forged Steel Snips



- Circular "Duckbill" forged steel snip
- Maneuvers and cuts easily to very tip of blade
- Cuts sheet metal, aluminum and steel siding, and plastics
- Cuts thin materials without tearing or catching



Length of Cut	Tool Length	Price
3"	12"	

Andy  
SNIP



Lightweight with the strength of steel

### Andy 12" Combination Snip

Malco

- Snug, Rounded handle loops that characterized the original.
- Aluminum handle with a snug fit and feel
- Full 3-inch cutting length
- Easily replaceable blades
- Optional snip holster

Length of Cut	Application	Weight	Tool Length	Price
3"	Cuts straight, left, right and 6" circles	16.7 oz.	12"	

### Downspout Crimper



Malco

- 5 Blade Crimper which produces a double crimp
- Downsizes without deforming down-spout
- Walls stay square for a tight fitting, leak proof connection
- Tool also features rust resistant plating
- Non-slip vinyl grips with hand stops provide added comfort and resistance to elements



Weight	Tool Length	Price
1.23 lbs.	9"	

### Forged Steel Hand Seamer

Malco

- Precise vee-notched depth graduations on jaws are in 1/4" increments
- Jaws are drop forged, high impact steel
- Hardened steel handles resist abuse
- Powerful compound leverage design
- Tool also features rust resistant nickel plating
- Non-slip vinyl grips with hand stops provide added comfort and resistance to elements



Item	Jaw Depth	Jaw Width	Weight	Tool Length	Price
3" Offset	1.25"	3.25"	24 oz.	8"	
6"	1.25"	6"	30 oz.	8"	

### Magnetic Tip Tape Measure



- Powerful magnetic 1-inch wide blade
- Abrasion-resistant nylon coating
- Double-riveted tip connection
- Rubber-clad housing



Item	Price
1" x 16'	
1" x 25'	
1" x 30'	

### Heavy Duty Caulk Gun



- Heavy duty professional model with thumb-activated pressure release
- Designed for use with spouted cartridge
- Powerful ratcheting action minimizes worker fatigue or need to warm up caulk
- User can regulate stroke to fit hand
- Hand puncture wire folds inside handle



Capacity	Carriage Diameter	Tool Length	Price
1/10 gallon	2"	8 1/2"	

### Utility Caulking Gun



- Slotted front for easy loading
- Handy puncture wire, folds inside handle



Capacity	Carriage Diameter	Tool Length	Price
1/10 gallon	2"	8 1/2"	

### Metal Cutting Blade



- Slash through metals quickly and accurately leaving clean, burr-free cuts behind
- Ideal for cutting steel studs, steel pipe, and steel sheet- for most mild steels under 1/4 inch
- Durable Triple Chip Grind (TCG) Metal Cutting Tooth Design maximizes cutting life and speed producing burr-free cuts

Diameter	Teeth	Arbor	Price
6-1/2"	48	5/8"	
7 1/4"	48	5/8"	
12"	60	1"	
14"	72	1"	

### Wood Cutting Blades

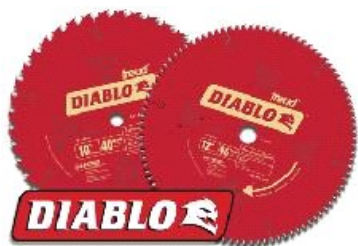

- Laser-cut stabilizer vents for reduced vibration and precise cuts
- Durable Micro Grain Titanium Carbide for razor-sharp cuts and long life
- Perma-SHIELD™ permanent non-stick coating prevents gumming and corrosion
- Laser-cut thin kerf gives fast, clean cuts

#### Framing

Diameter	Teeth	Arbor	Price
6-1/2"	24	5/8"	
7-1/4"	24	5/8"	

#### Finish

Diameter	Teeth	Arbor	Price
7 1/4"	40	5/8"	
8-81/4"	40	5/8"	
8-1/2"	60	5/8"	
12"	80	1"	

#### Ultra Finish

Diameter	Teeth	Arbor	Price
10"	80	1"	
12"	96	1"	

#### General Purpose

Diameter	Teeth	Arbor	Price
10"	24	1"	
10"	50	1"	
12"	44	1"	

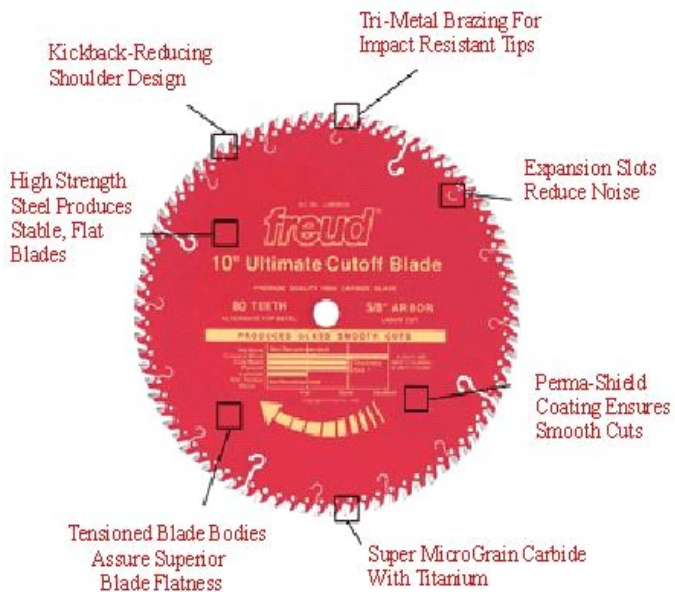

### Metal Cutting Blades

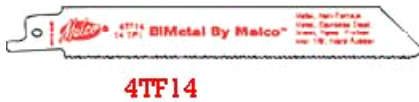

- High Speed Steel cutting edge, welded to a flexible High Carbon Steel back
- Superior manufacturing process outperforms all other

Item #	Length	Application	Price
3MC24	4"	Cuts sheet metal, pipe, profiles up to 18 ga.	
3TF18	4"	Cuts profiles up to 18 ga.	
4TF14	6"	Cuts all metals including stainless steel over 1/8"	

### the Hole in One™ HOLE SAW



### Hole-In-One Saw



- One piece arbor and hole saw combinations eliminates the need for separate arbor attachments
- 4/6 variable pitch teeth milled into high speed steel edge and micro-welded to body
- Shatterproof alloy steel body
- 1 9/16 inch cutting depth



Size	Price
1 1/16"	
1/4" Pilot Bit	



### Steel Cutting Abrasive Blade

- Thin kerf blade excellent for cutting structural steel
- Runs smoother and lasts longer than comparable brands



Diameter	Arbor	Price
4 1/2" x 1/16"	5/8"	
7 1/4" x 1/16"	5/8"	
7-1/4" x 1/8"	5/8"	



*Malco*

### Step Bit



- Double flute design assures penetration of soft and thin materials
- Drill holes without burring or deforming stock
- Perfect for using as a “hole-opening” reamer
- Completely resharpenable

Size	Price
1/4” to 3/4”	

*Malco*

### Double ended Sheet Metal Bit



- Excellent for pre-drilling roof and wall panes
- Cutting tips on both ends
- 135 deg. Split point

Size	Length of Twist	Quantity	Price
2”	1/2”	12	

**Powers**  
FASTENERS

### S-4 Plus SDS

- Designed for use in a rotary hammer equipped with an SDS (slotted drive shaft) type chuck
- Can be used for drilling in concrete, block, brick, and soft stone



Size	Price
1/4” x 4”	

**Powers**  
FASTENERS

### Wedge-Bit

- Specially made for installing Wedge-Bolt anchors
- Has a special, matched tolerance range designed to provide optimum performance for the anchor



Size	Price
1/2” x 6”	
1/2” x 10”	
5/8” x 8”	

**Powers**  
FASTENERS

### Rebar Cutter

- A quick, easy method for drilling through mesh or rebar embedded in concrete
- Designed to fit a standard rotary drill with a 1/2” Jacobs style chuck



Size	Price
1/2” x 12”	
5/8” x 12”	





### Pigskin Gloves

- Full grain pigskin leather glove
- Gunn-cut design with keystone thumb
- Shirred elastic back
- Self hemmed cuff

Size	Price
Small/Medium/Large	



### Pile Lined Glove

- Tough split leather with pile lining
- Gunn-cut design with keystone thumb
- Shirred elastic back
- Self hemmed open cuff

Size	Price
Small/Medium/Large	



### Ratcheting Hard Hat

- Universal Slots accommodate hearing, welding, and face shield accessories
- Comfortable 6-point nylon suspension
- CoolmaxCM terrycloth sweat band
- Ratchet hold cap in place for a secure fit

Color	Price
Yellow	
White	

### Safety Glasses



- Hard-coated 100% polycarbonate
- Dual 9.75 base curvature viewing areas for wide unobstructed vision
- Lens blocks more than 99.9% of UV-A and UV-B light

Style	Price
Clear	
Mirrored	



### Reusable Ear Plugs

- NRR 26 dB
- Corded, washable and reusable

Size	Price
One Size	

### Cupolas



(shown with louvers)

- All cupolas are pre-painted 29ga steel construction
- Available in over 100 standard colors
- Optional weather vane
- All metal edges are hemmed
- No need to worry about red-rust
- Roof and sides interlock for weather tight connection
- Shipped Knock-Down, assembles at the job site
- Assembly instructions included
- Our premium flashing kit is now available. It raises the cupola 3 1/2" higher above the peak of the roof, plus it gives the sides a fuller look from the ground
- \* 48" Cupola prices do not include freight \*



(shown with windows)

	<i>All prices up to 4/12 pitch</i>	<b>Price</b>	<b>Price</b>
<b>Size</b>	<b>Description</b>	<i>Louvers</i>	<i>Windows</i>
24" x 24"	Standard Flashing		
24" x 24"	Premium Flashing		
24" x 24"	Universal Base		
36" x 36"	Standard Flashing		
36" x 36"	Premium Flashing		
36" x 36"	Universal Base		
48" x 48"	Standard Flashing		
48" x 48"	Premium Flashing		
48" x 48"	Universal Base		

### Weathervanes



- Stock & non-stock weather vanes come standard with black finish
- See the brochure for all the different styles available



	<b>Price</b>	<b>Price</b>
<b>Size</b>	<i>Stock</i>	
30"		
46"		

### Stall Fronts (All aluminum components)

#### 5'7" Stall Front

Quantity	Size	Description
2	5'-7"	Punched Stall Rails
17	30"	Bars
ADDITIONAL MATERIALS REQUIRED		
14	2" X 6" X 8'	Tongue & Groove
1	2" x 6" x 10'	Track Board and Fasteners



#### 4' x 8' Sliding Door Kit

Quantity	Size	Description
1	8'	Sidemount Track
2		Wood Door Trolleys
1		Sliding Bolt Latch
1		Small Adjustable Stay Roller
1		Non-Adjustable Door Stop
2	8'	Plain Stall Rails
2	44 1/2"	Punched Stall Rails
10	30"	Bars
ADDITIONAL MATERIALS REQUIRED		
14	2" X 6" X 4'	Tongue & Groove and Fasteners

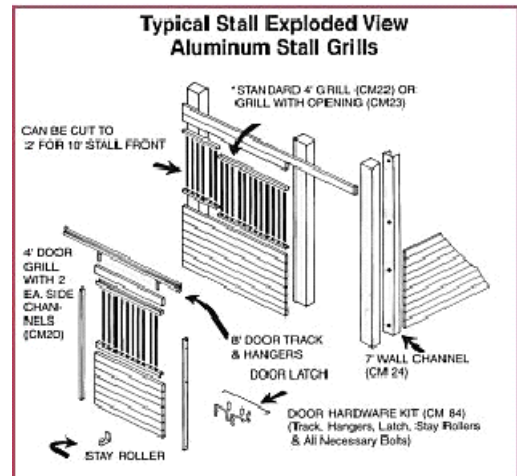

#### 7'-7" Stall Front

Quantity	Size	Description
2	7'-7"	Punched Stall Rails
22	30"	Bars
ADDITIONAL MATERIALS REQUIRED		
14	2" X 6" X 10'	Tongue & Groove
1	2" x 6" x 12'	Track Board and Fasteners

#### Stall Feed Door

Quantity	Size	Description
1	24" x 28"	Stall Feed Door
ADDITIONAL MATERIALS REQUIRED		
None		

#### 10' Stall Partition

Quantity	Size	Description
2	10'	Punched Stall Rails
30	30"	Bars
2	8'	Plain Stall Rails
ADDITIONAL MATERIALS REQUIRED		
14	2" x 6" x 10'	Tongue & Groove and Fasteners

#### 12' Stall Partition

Quantity	Size	Description
2	12'	Punched Stall Rails
35	30"	Bars
2	8'	Plain Stall Rails
ADDITIONAL MATERIALS REQUIRED		
14	2" x 6" x 12'	Tongue & Groove and Fasteners



**Master Flash**



**Retrofit**

“When over the top is not an option”

### Black EPDM

- Great for residential or commercial
- Forms over virtually any profile
- Withstand up to 212 deg.
- Maximum resistance to UV rays and weathering
- Base flexibility
- Easy on-site customization
- Available in custom color
- Retrofit is useful for electrical weatherheads

Model	Size	Price
# 2	1 1/4" - 3"	
# 3	1/4" - 4"	
# 4	3" - 6"	
# 6	5" - 9"	
# 7	6" - 11"	
# 8	7" - 13"	
# 9	10" - 18"	
# 10	13" - 26"	
# 1 Retrofit	1" - 4"	



**Hi - Temp**

### Hi-Temp Silicone Pipe Flash

- Great for heat vents and stove pipes
- Temp range of -100 deg. to +500 deg.

Model	Size	Price
# 4 Hi-temp	3" - 6"	
# 5 Hi-temp	4" - 7"	
# 6 Hi-temp	5" - 9"	
# 7 Hi-temp	6" - 11"	
# 8 Hi-temp	7" - 13"	
#9 Hi-temp	9-1/2" - 20-1/2"	

## Light Panels

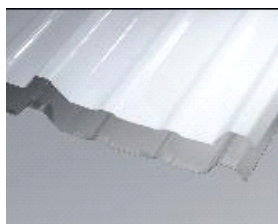

### Polycarbonate

- Up to 20% stronger than fiberglass
- 100% U.V. Protection
- 90% light transmission
- Clear as glass . . . won't yellow with age
- Custom cut to nearest 1 inch increments
- Available in White and Clear

Profile	Price
3' Magna Rib	
3' PBR	



### Fiberglass

- 26% U.V. protection
- Allows 66% light transmission
- Great for Sky-lights and decks
- Custom cut to nearest 1 foot increments

Profile	Price
2' Corrugated	
2' Delta	
3' Magna Rib	
3' PBR	



- ### Magnetic Holding Tool
- For use on all steel constructions
  - Acts as a second pair of hands
  - Holds insulation in place
  - Strong enough to carry metal panels

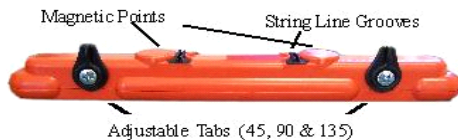

Price



- ### 12" & 16" Crimp Tool
- Excellent for making a closed ridge
  - May be used for many other applications
  - Constructed of heavy gauge steel

Size	Price
12"	
16"	



**Wonder  
Gloves**

- ### Wonder Gloves
- Breathable polyester knit shell
  - Unique textured latex coating provides secure grip
  - Protects against cuts and abrasions
  - No problem picking up nails and washers

Size	Price
Medium/Large/X-Large	



### EEZY-FOAMY Cutting Fluid

- Specially designed foaming action . . . stays where you spray it
- Works in vertical and horizontal drilling positions
- Chemical refrigeration lubricates the tool and work piece
- Improves productivity, tool life, and part finish

Size	Price
14 oz. can	



- ### Magnetic Nut Driver
- Designed with the painted screw head in mind
  - Slightly oversized with rounded corners
  - Reduces the risk of marring the paint on the screw
  - Works great with unpainted screw

Size	Price
1/4"	
3/8"	
5/16"	